

UPS3

Installation and operating instructions



English (GB) Installation and operating instructions

Original installation and operating instructions

These installation and operating instructions describe Grundfos UPS3.

Sections 1-4 give the information necessary to be able to unpack, install and start up the product in a safe way.

Sections 5-12 give important information about the product, as well as information on service, fault finding and disposal of the product.

CONTENTS

	Page
1. General information	2
1.1 Hazard statements	2
1.2 Notes	3
2. Receiving the product	3
2.1 Inspecting the product	3
2.2 Scope of delivery	3
3. Installing the product	3
3.1 Mechanical installation	3
3.2 Pump positions	4
3.3 Control box positions	4
3.4 Electrical connection	5
3.5 Assembling the installer plug	5
3.6 Insulating the pump housing	6
4. Starting up the product	7
4.1 Before startup	7
4.2 Starting up the pump	7
4.3 Venting the pump	7
5. Product introduction	8
5.1 Product description	8
5.2 Applications	8
5.3 Pumped liquids	8
5.4 Identification	8
5.5 Accessories	9
6. Control functions	11
6.1 Operating panel	11
6.2 Control modes	11
6.3 Control signal	12
6.4 Pump performance	14
7. Setting the product	15
7.1 Setting the PWM input signal	15
8. Servicing the product	16
8.1 Dismantling the product	16
8.2 Dismantling the plug	16
9. Fault finding the product	17
9.1 Deblocking the shaft	17
10. Technical data	18
10.1 Dimensions, UPS3 15-50/65	18
11. Performance curves	19
11.1 Curve conditions	19
11.2 Performance curve, UPS3 15-50/65	19
12. Disposing of the product	20



Read this document and the quick guide before you install the product. Installation and operation must comply with local regulations and accepted codes of good practice.



This appliance can be used by children aged from 8 years and above and persons with reduced physical, sensory or mental capabilities or lack of experience and knowledge if they have been given supervision or instruction concerning use of the appliance in a safe way and understand the hazards involved.

Children shall not play with the appliance. Cleaning and user maintenance shall not be made by children without supervision.

1. General information

1.1 Hazard statements

The symbols and hazard statements below may appear in Grundfos installation and operating instructions, safety instructions and service instructions.



DANGER

Indicates a hazardous situation which, if not avoided, will result in death or serious personal injury.



WARNING

Indicates a hazardous situation which, if not avoided, could result in death or serious personal injury.



CAUTION

Indicates a hazardous situation which, if not avoided, could result in minor or moderate personal injury.

The text accompanying the three hazard symbols DANGER, WARNING and CAUTION is structured in the following way:



SIGNAL WORD

Description of hazard

Consequence of ignoring the warning.
- Action to avoid the hazard.

The hazard statements are structured in the following way:

1.2 Notes

The symbols and notes below may appear in Grundfos installation and operating instructions, safety instructions and service instructions.



Observe these instructions for explosion-proof products.



A blue or grey circle with a white graphical symbol indicates that an action must be taken.



A red or grey circle with a diagonal bar, possibly with a black graphical symbol, indicates that an action must not be taken or must be stopped.



If these instructions are not observed, it may result in malfunction or damage to the equipment.



Tips and advice that make the work easier.

2. Receiving the product

2.1 Inspecting the product

CAUTION

Crushing of feet

Minor or moderate personal injury
- Wear safety shoes when opening the box and handling the product.



Check that the product received is in accordance with the order.

Check that the voltage and frequency of the product match voltage and frequency of the installation site. See section [5.4.1 Nameplate](#).

2.2 Scope of delivery

The box contains the following items:

- UPS3 pump
- installer plug
- two gaskets
- quick guide.

3. Installing the product

DANGER

Electric shock

Death or serious personal injury
- Switch off the power supply before starting any work on the product. Make sure that the power supply cannot be accidentally switched on.



CAUTION

Crushing of feet

Minor or moderate personal injury
- Wear safety shoes when opening the box and handling the product.



Installation must be carried out by trained persons in accordance with local regulations.



The pump must always be installed with a horizontal motor shaft within $\pm 5^\circ$.

3.1 Mechanical installation



Mechanical installation must be carried out by trained persons in accordance with local regulations.

3.1.1 Mounting the product

1. The arrows on the pump housing indicate the flow direction through the pump. See fig. 1.
2. Fit the two gaskets supplied with the pump when you mount the pump in the pipe. Install the pump with a horizontal motor shaft within $\pm 5^\circ$. See fig. 2. See also section [3.3 Control box positions](#).
3. Tighten the fittings. See fig. 3.

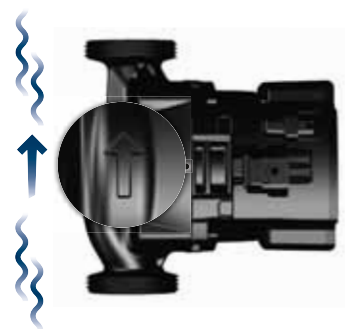

Fig. 1 Flow direction

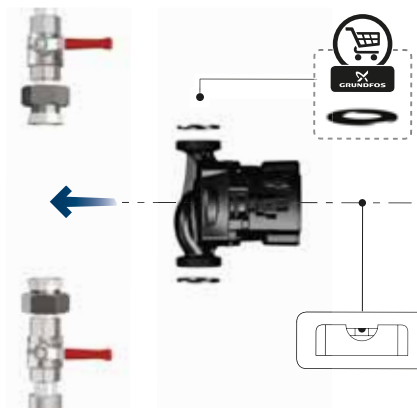

Fig. 2 Pump installation

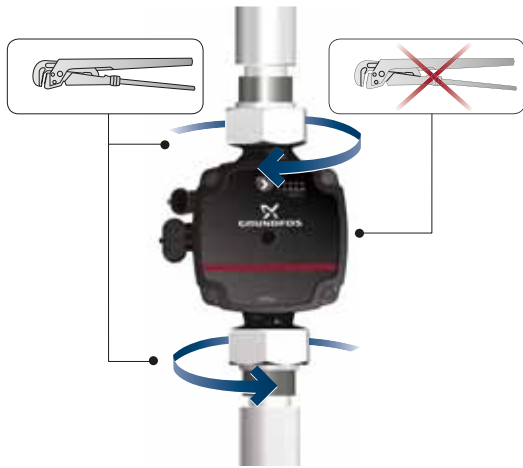

Fig. 3 Tightening the fittings

TM07 0370 1518

3.2 Pump positions

Always install the pump with a horizontal motor shaft within $\pm 5^\circ$. Do not install the pump with a vertical motor shaft. See fig. 4, bottom row.

- Pump installed correctly in a vertical pipe. See fig. 4, top row, left.
- Pump installed correctly in a horizontal pipe. See fig. 4, top row, right.

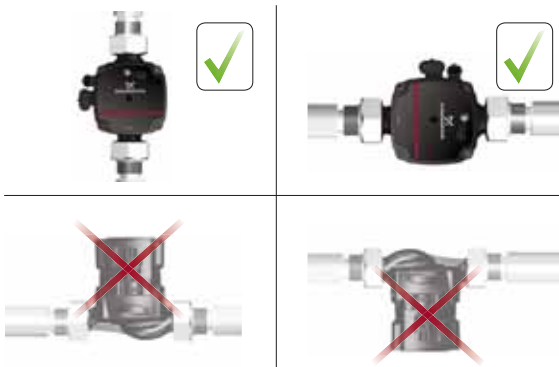

Fig. 4 Pump positions

TM07 0371 1518

3.3 Control box positions

DANGER

Electric shock



Death or serious personal injury
- Switch off the power supply before starting any work on the product. Make sure that the power supply cannot be accidentally switched on.

CAUTION

Hot surface



Minor or moderate personal injury
- The pump housing may be hot due to the pumped liquid being scalding hot. Close the isolating valves on both sides of the pump and wait for the pump housing to cool down.

CAUTION

Pressurised system



Minor or moderate personal injury
- Before dismantling the pump, drain the system or close the isolating valves on both sides of the pump. The pumped liquid may be scalding hot and under high pressure.

The control box can be mounted in all positions. See fig. 5.

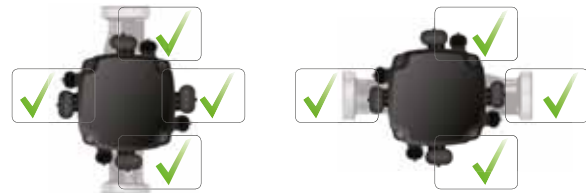
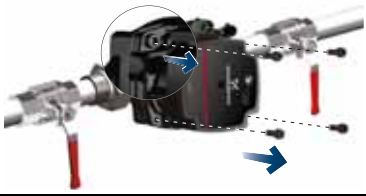

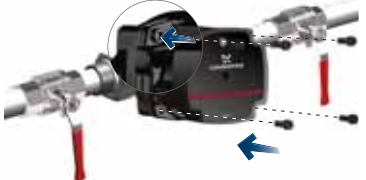

Fig. 5 Possible control box positions

TM06 7297 0918

3.3.1 Changing the control box position

Step	Action	Illustration
1	Make sure that the inlet and outlet valves are closed. Unscrew the screws on the pump head.	 TM07 0372 1518
2	Turn the pump head to the desired position.	 TM07 0373 1518
3	Refit the screws on the pump head.	 TM07 0374 1518

3.4 Electrical connection



DANGER

Electric shock

Death or serious personal injury
 - All electrical connections must be carried out by a qualified electrician in accordance with local regulations.



DANGER

Electric shock

Death or serious personal injury
 - Switch off the power supply before starting any work on the product. Make sure that the power supply cannot be accidentally switched on.



DANGER

Electric shock

Death or serious personal injury
 - Connect the pump to earth.







DANGER

Electric shock

Death or serious personal injury
 - In case of an insulation fault, the fault current may be a pulsating DC. Observe national legislation about requirements for and selection of Residual Current Device (RCD) when installing the pump.

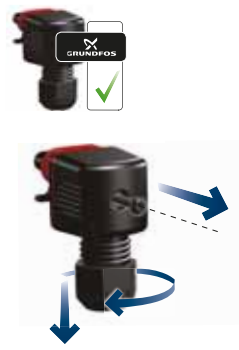
- The motor requires no external motor protection.
- Check that the supply voltage and frequency correspond to the values stated on the nameplate. See section [5.4.1 Nameplate](#).
- Connect the pump to the power supply with the plug supplied with the pump. See steps 1 to 7.

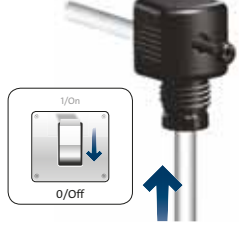
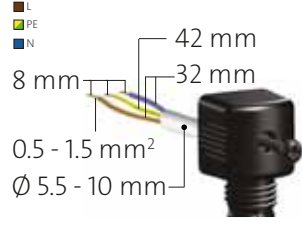
3.5 Assembling the installer plug

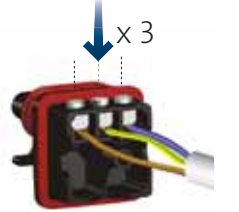
Step	Action	Illustration
1	Loosen the cable gland and unscrew the union nut in the centre of the terminal cover.	 TM06 8542 0918
2	Detach the terminal cover.	 TM06 8543 0918
3	Pull the power cable through the cable gland and terminal cover.	 TM06 8544 0918
4	Strip the cable conductors as illustrated.	 TM06 8545 0918
5	Loosen the screws on the power supply plug and connect the cable conductors.	 TM06 8546 0918 - TM06 8547 0918
6	Tighten the screws on the power supply plug.	 TM06 8548 0918

Step	Action	Illustration
7	<p>Refit the terminal cover. See A.</p> <p>Note: It is possible to turn the power supply plug on the side for a 90 ° cable entry. See B.</p>	
8	Tighten the union nut.	
9	Tighten the cable gland onto the power supply plug.	
10	Insert the power supply plug into the male plug on the pump.	

TM06 8549 0918 - TM06 8550 0918

TM06 8551 0918

TM06 8552 0918

TM07 0376 1518

3.6 Insulating the pump housing

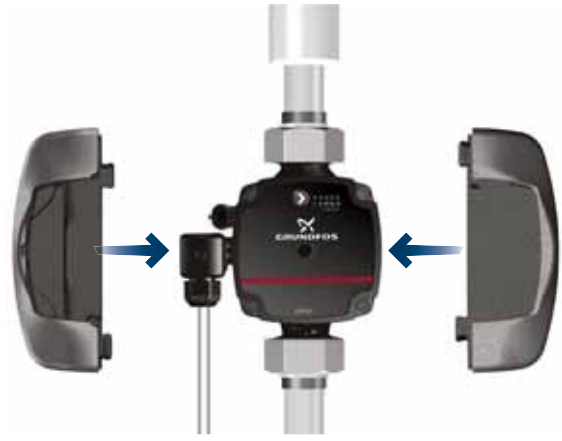

TM07 0375 1518

Fig. 6 Insulating the pump housing

You can reduce the heat loss from the pump and pipe by insulating the pump housing and the pipe with insulating shells, which can be ordered as an accessory. See section [5.5.2 Insulating shells](#).



Do not insulate the control box or cover the operating panel.



4. Starting up the product

4.1 Before startup

Do not start the pump until the system has been filled with liquid and vented. Make sure that the required minimum inlet pressure is available at the pump inlet. See section 10. *Technical data*.

When using the pump for the first time, the system must be vented. See section 4.3 *Venting the pump*. The pump is self-venting through the system.

4.2 Starting up the pump

Step	Action	Illustration
1	Open the inlet and outlet valves.	
2	Switch on the power supply.	
3	The lights in the operating panel indicates that the power supply has been switched on and the pump is running.	

TM07 0377 1518

TM06 8555 1317

TM07 0378 1518

4.3 Venting the pump



Fig. 7 Venting the pump

Small air pockets trapped inside the pump may cause noise when starting up the pump. However, because the pump is self-venting through the system, the noise ceases over a period of time.

To speed up the venting process, do as follows:

1. Set the pump to speed III using the button on the operating panel.
2. Let the pump run for minimum 30 minutes. How fast the pump is vented depends on the system size and design.

When you have vented the pump, that is when the noise has ceased, set the pump according to the recommendations. See section 6. *Control functions*.



The pump must not run dry.



The pump is from factory set to constant curve III.

TM07 1416 1618

5. Product introduction

5.1 Product description

UPS3 can be used as stand-alone or integrated circulator pump in existing systems as replacement or in new systems with either variable or constant flow rate.

The speed can be controlled by a low-voltage PWM (Pulse Width Modulation) signal.

High-efficiency ECM (Electronically Commutated Motor) pumps, such as UPS3, must not be speed-controlled by an external speed controller varying or pulsing the supply voltage.

5.1.1 Model type

These installation and operating instructions cover UPS3. The model type is stated on the packaging and nameplate.

5.2 Applications

The pump is designed for circulating liquids in all heating systems. The pumps are suitable for the following systems:

- Systems with constant or variable flows where it is desirable to optimise the pump duty point.
- Installation in existing systems where the differential pressure of the pump is too high during periods of reduced flow demand.
- Installation in new systems for automatic adjustment of the performance to flow demands without the use of bypass valves or similar expensive components.

5.3 Pumped liquids



CAUTION
Flammable material

Minor or moderate personal injury
- Do not use the pump for flammable liquids, such as diesel oil and petrol.



CAUTION
Corrosive substance

Minor or moderate personal injury
- Do not use the pump for aggressive liquids, such as acids and seawater.

The pump is suitable for clean, thin, non-aggressive and non-explosive liquids, not containing solid particles, fibres or mineral oil.

In heating systems, the water must meet the requirements of accepted standards on water quality in heating systems, for example the German guideline VDI 2035.

Mixtures of water with antifreeze media such as glycol with a kinematic viscosity lower than 10 mm²/s (10 cSt). When selecting a pump, the viscosity of the pumped liquid must be taken into consideration. If the pump is used for a liquid with a higher viscosity, the hydraulic performance of the pump is reduced.

5.4 Identification

5.4.1 Nameplate

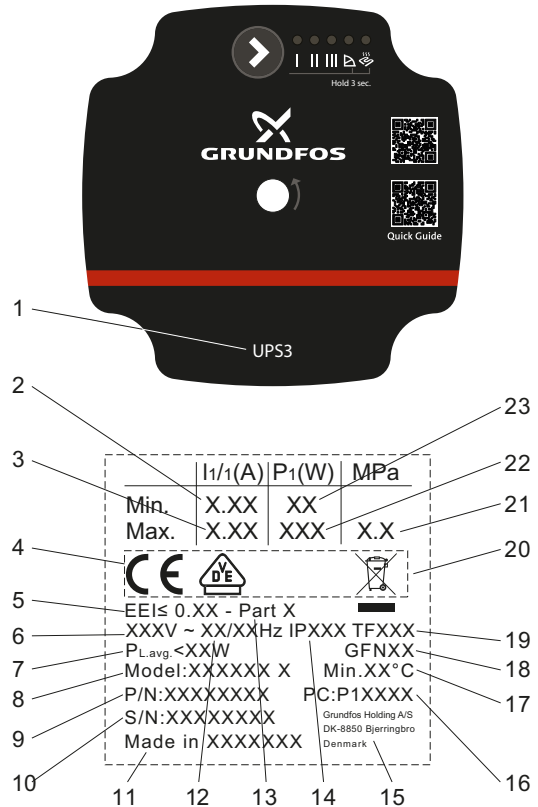

Fig. 8 Nameplate

Pos.	Description
1	Pump name
2	Minimum current [A]
3	Maximum current [A]
4	CE mark and approvals
5	Energy Efficiency Index, EEI
6	Voltage [V]
7	Average power input PL, avg (Ecodesign regulation)
8	Model designation
9	Product number
10	Serial number
11	Country of origin
12	Frequency [Hz]
13	Part, according to EEI
14	Enclosure class
15	Manufacturer's name and address
16	Production code: <ul style="list-style-type: none"> • 1st and 2nd figures: Production site code • 3rd and 4th figures: year • 5th and 6th figures: week
17	Minimum liquid temperature
18	Product mark (legal product code)
19	TF class
20	Crossed-out wheeled bin according to EN 50419
21	Maximum system pressure
22	Maximum input power [W]
23	Minimum input power [W]

TM07 0791 1618

5.4.2 Type key

Example	UPS3	15	50/65	130
Pump type				
Nominal diameter (DN) of inlet and outlet ports [mm]				
Maximum head [dm]				
[]: Cast-iron pump housing				
Port-to-port length [mm]				

5.5 Accessories

5.5.1 Unions and valve kits

Product numbers, unions						
Union nut with internal threads				Union nut with external threads		
UPS3	Connection	Rp			R	
		3/4	1	1 1/4	1	1 1/4
15-xx	G 1 1/2	529921	529922	529821	529925	529924

Note: The product numbers are always for one complete set, including gaskets. The product number for the standard sizes is printed in bold.

G-threads have a cylindrical form in accordance with the EN ISO 228-1 standard and are not sealing the thread. It requires a flat gasket. You can only screw male G-threads (cylindrical) into female G-threads. The G-threads are standard thread on the pump housing.

R-threads are tapered external threads in accordance with the EN 10226-1 standard.

Rc- or Rp-threads are internal threads with either tapered or cylindrical (parallel) threads. You can screw male R-threads (conical) into female Rc- or Rp-threads. See fig. 9.

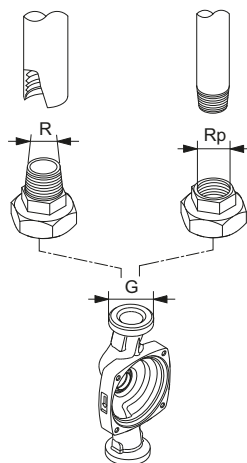

TM07 7425

Fig. 9 G-threads and R-threads

5.5.2 Insulating shells

The accessory set is tailored to the individual pump type. The insulating shells enclose the entire pump housing and are easy to fit around the pump.

Pump type	Product number
UPS3 15-50/65	99270706

5.5.3 Cables and plugs

The pump has two electrical connections: the power supply and the control signal connection.

Power supply connection

The installer plug is supplied with the pump and is available as an accessory.

Power cable adapters are also available as accessories.

Control signal connection





The control signal cable connection has three conductors: the signal input, the signal output and the signal reference. Connect the cable to the control box by a mini superseal plug. See [7.1 Setting the PWM input signal](#). The optional signal cable is available as an accessory. The cable length must not exceed 3 metres.



TM06 4414

Fig. 10 Mini superseal plug

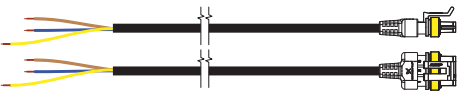
Conductor	Colour
Signal input	Brown
Signal reference	Blue
Signal output	Black

Product	Product description	Length [mm]	Product number
	Installer plug		99439948
	Mini superseal signal cable (PWM input signal)	2000	99165309
	Superseal power cable	2000	99198990
	Power cable adapter: Superseal Molex cable adapter, overmoulded	150	99165311
	Power cable adapter: Superseal Volex cable adapter, overmoulded	150	99165312

6. Control functions

6.1 Operating panel



Fig. 11 Operating panel

Symbol	Description
	Button
I, II, III	Constant curve or constant speed curve I, II and III
	Proportional-pressure mode I, II
	Constant-pressure mode, I, II

The operating panel shows the following:

- The control mode, after pressing the button
- Alarm status

6.1.1 Alarm or warning

If the pump has detected one or more alarms or warnings, the first LED switches from green to red. When the fault has been resolved the operating panel switches back to operating status. See section 9. [Fault finding the product](#).

6.2 Control modes

The pump has seven different control modes. Learn more about them in the following sections.

6.2.1 Constant curve or constant speed, I, II or III (factory setting)

At constant-curve or constant-speed operation, the pump runs at a constant curve. The pump performance follows the selected performance curve, I, II or III. See fig. 14 where II has been selected.

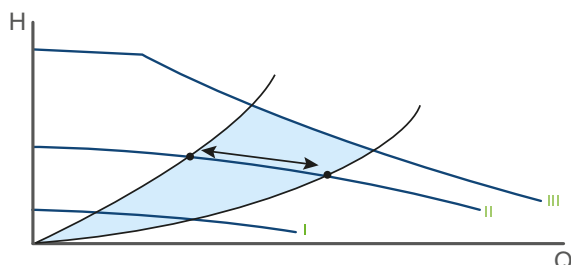

Fig. 12 Constant-curve/speed curve

The selection of the constant-curve or constant-speed setting depends on the characteristics of the heating system in question.



The pump is factory-set to constant curve III.

System type	Recommended control mode	Alternative control mode
One-pipe heating system	Constant-pressure mode. See section 6.2.3 Constant pressure I, II .	Constant curve or constant speed, I, II or III.

6.2.2 Proportional pressure I, II

In proportional-pressure mode the pump performance follows the selected performance curve I or II and adjusts the pump performance to the actual heat demand in the system following the proportional-pressure curve.

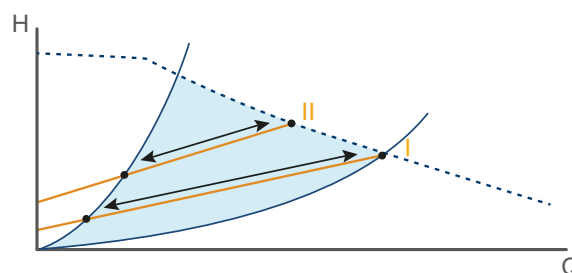

Fig. 13 Proportional-pressure curve

System type	Recommended control mode	Alternative control mode
Two-pipe system	Proportional-pressure mode*	Constant curve or constant speed I, II, III, see section 6.2.1 Constant curve or constant speed, I, II or III (factory setting) .

* Proportional pressure mode is not recommended in heating systems that include an automatic bypass valve to ensure a minimum flow for the heating appliances.

6.2.3 Constant pressure I, II

In constant-pressure mode the pump follows the selected constant-pressure curve I or II, adjusts the pump performance to the actual heat demand in the system following the selected constant-pressure curve.

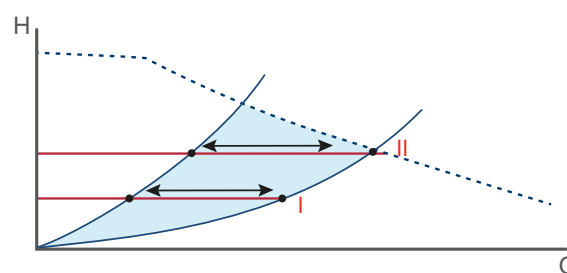

Fig. 14 Constant-pressure curve

System type	Recommended control mode	Alternative control mode
Underfloor heating system	Constant-pressure mode	Constant curve or constant speed I, II, III, see section 6.2.1 Constant curve or constant speed, I, II or III (factory setting) .

6.2.4 Changing from recommended to alternative pump setting

Heating systems are relatively slow systems that cannot be set to the optimum operation within minutes or hours.

If the recommended pump setting does not give the desired distribution of heat in the rooms of the house, change the pump setting to the shown alternative.

6.2.5 Selecting the control modes

Proportional pressure

We recommend proportional-pressure mode in variable flow systems with relatively large pressure losses in the distribution pipes such as:

- two-pipe heating systems with thermostatic valves and long distribution pipes
- two-pipe heating systems with thermostatic valves and high pressure losses in system parts with total flow
- primary circuit pumps in systems with large pressure losses in the primary circuit.

Note: Proportional-pressure mode is not recommended in heating systems that includes an automatic bypass valve to ensure a minimum flow for the heating appliances.

Constant pressure

We recommend constant-pressure mode in variable flow systems with relatively small pressure losses in the distribution pipes such as:

- two-pipe heating systems with thermostatic valves and dimensioned for natural circulation (former gravity systems)
- two-pipe heating systems with thermostatic valves and low pressure losses in system parts with total flow
- one-pipe heating systems with thermostatic valves or pipe balancing valves
- underfloor heating systems with zone valves
- primary circuit pumps in systems with small pressure losses in the primary circuit.

Constant curve

We recommend constant-curve mode in constant-flow systems, where both a constant flow rate and a constant head are required, such as:

- heat surfaces
- replacement for uncontrolled circulator pumps, for instance integrated in boilers.

6.3 Control signal

The pump can be controlled via a digital low-voltage pulse-width modulation (PWM) signal.

The square-wave PWM signal is designed for a 100 to 4,000 Hz frequency range. The PWM signal is used to select the speed (speed command) and as feedback signal. The PWM frequency on the feedback signal is fixed at 75 Hz in the circulator pump.

For instructions on how to set the connection, see section [7.1 Setting the PWM input signal](#).

Duty cycle

$$d \% = 100 \times t/T$$

Example	Rating
T = 2 ms (500 Hz)	$U_{iH} = 4-24 \text{ V}$
t = 0.6 ms	$U_{iL} \leq 1 \text{ V}$
d % = $100 \times 0.6 / 2 = 30 \%$	$I_{iH} \leq 10 \text{ mA}$ (depending on U_{iH})

Example

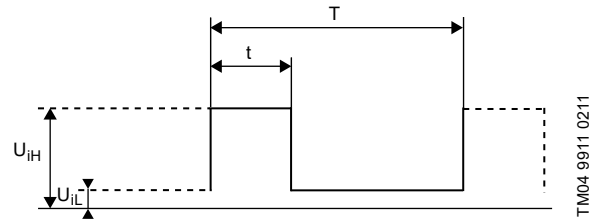

Fig. 15 PWM signal

Abbreviation	Description
T	Period of time [sec.]
d	Duty cycle [t/T]
U_{iH}	High-level input voltage
U_{iL}	Low-level input voltage
I_{iH}	High-level input current

6.3.1 Interface

The pump's interface consists of an electronic part connecting the external control signal to the circulator pump. The interface translates the external signal into a signal type that the microprocessor can understand.

In addition, the interface ensures that the user cannot get into contact with dangerous voltage if touching the signal wires when power is connected to the circulator pump.

Note: "Signal ref." is a signal reference with no connection to protective earth.

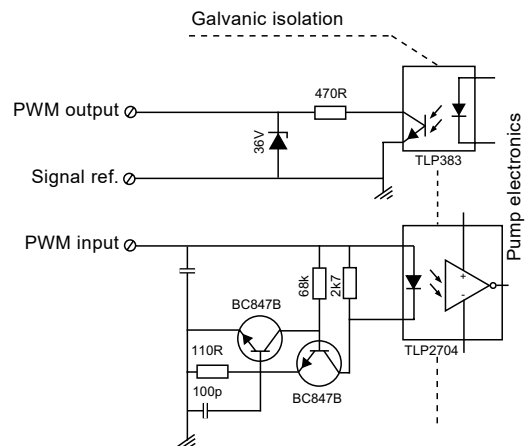
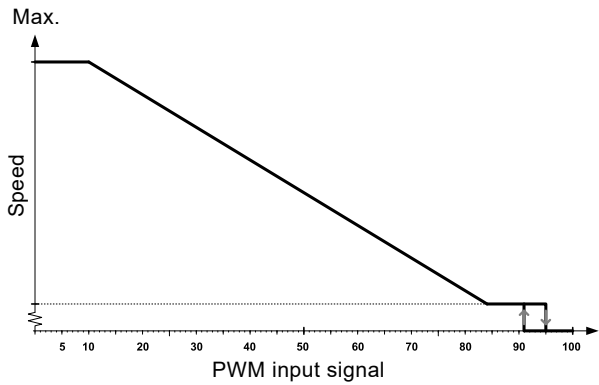

Fig. 16 Schematic drawing, interface

TM06 0787 0914

6.3.2 PWM input signal profile A (heating)

The pump runs on constant-speed curves depending on the PWM input signal. The speed decreases when the PWM value increases. If the PWM signal equals zero (0 VDC), the pump will switch to the control mode selected before connecting to a PWM signal.



TM06 9136 1617

Fig. 17 PWM input signal profile A (heating)

PWM input signal [%]	Pump status
≤ 10	Maximum speed: max.
> 10 / ≤ 84	Variable speed: min. to max.
> 84 / ≤ 91	Minimum speed: IN
> 91/95	Hysteresis area: on/off
> 95 or ≤ 100	Standby mode: off

6.3.3 PWM feedback signal

The PWM feedback signal offers pump information like in bus systems:

- current power consumption (accuracy ± 2 % of PWM signal)
- warning
- alarm.

Alarms

Alarm output signals are available because some PWM output signals are dedicated to alarm information. If a supply voltage is measured below the specified supply voltage range, the output signal is set to 75 %. If the rotor is locked due to deposits in the hydraulics, the output signal is set to 90 % because this alarm has a higher priority. See fig. 18.

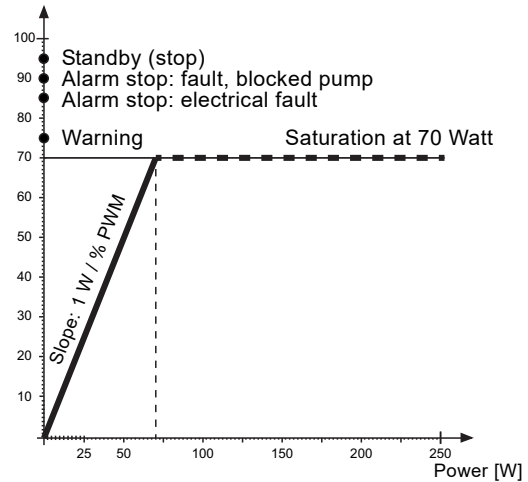

TM07 1313 1118

Fig. 18 PWM feedback signal - power consumption

Data

Maximum rating	Symbol	Value
PWM frequency input with high-speed optocoupler	f	100-4000 Hz
Guaranteed standby power consumption		< 1 W
Rated input voltage - high level	U _{iH}	4-24 V
Rated input voltage - low level	U _{iL}	< 1 V
High-level input current	I _{iH}	< 10 mA
Input duty cycle	PWM	0-100 %
PWM frequency output, open collector	f	75 Hz ± 5 %
Accuracy of output signal regarding power consumption	-	± 2 % (of PWM signal)
Output duty cycle	PWM	0-100 %
Collector emitter breakdown voltage on output transistor	U _c	< 70 V
Collector current on output transistor	I _c	< 50 mA
Maximum power dissipation on output resistor	P _R	125 mW
Zener diode working voltage	U _z	36 V
Maximum power dissipation in Zener diode	P _z	300 mW

6.4 Pump performance

Figure 19 shows the relation between pump setting and pump performance by means of curves.

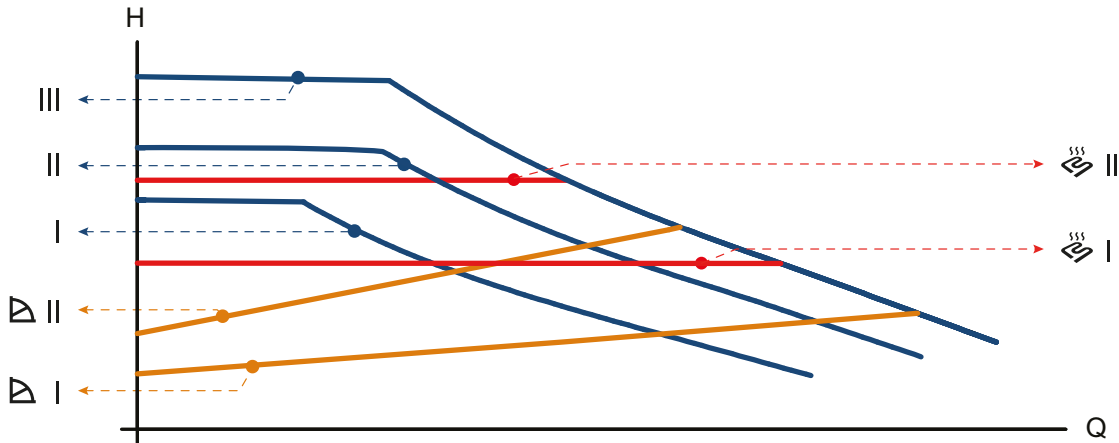



Fig. 19 Pump setting in relation to pump performance

TM07 1541 1618





Setting	Pump curve	Function
I	Constant curve or constant speed I	The pump runs at a constant speed and consequently on a constant curve. At speed I, the pump is set to run on the minimum curve under all operating conditions.
II	Constant curve or constant speed II	The pump runs at a constant speed and consequently on a constant curve. At speed II, the pump is set to run on the intermediate curve under all operating conditions.
III	Constant curve or constant speed III (factory setting)	The pump runs at a constant speed and consequently on a constant curve. At speed III, the pump is set to run on the maximum curve under all operating conditions. Quick venting of the pump can be obtained by setting the pump to speed III for a short period.
	Proportional-pressure mode I, II	The duty point of the pump will move up or down on a proportional-pressure curve, depending on the heat demand in the system. The head (pressure) is reduced at falling heat demand and increased at rising heat demand.
	Constant-pressure mode I, II	The duty point of the pump will move out or in on a constant-pressure curve, depending on the heat demand in the system. The head (pressure) is kept constant, irrespective of the heat demand.

7. Setting the product





To set the product use the button on the operating panel. Every time you press the button, the pump setting is changed. The LEDs will indicate the chosen control mode. To learn more about each control mode, see section 6.2 *Control modes*.

To select a proportional-pressure or constant-pressure curve, press and hold the button for 3 seconds. To return to constant-curve settings, press and hold the button for 3 seconds.

Control modes for constant curve

Display	Control mode
	Constant curve 1
	Constant curve 2
	Constant curve 3
	PWM profile A The LED flashes.

Control modes for proportional-pressure and constant-pressure curve

Display	Control mode
	Proportional pressure 1 The LEDs flash.
	Proportional pressure 2 The LEDs flash.
	Constant pressure 1 The LEDs flash.
	Constant pressure 2 The LEDs flash.



The pump is factory set to constant curve III.

7.1 Setting the PWM input signal

To enable the external control mode (PWM profile A), you need a signal cable connected to an external system. The cable connection has three conductors: the signal input, the signal output and the signal reference.

Conductor	Colour
Signal input	Brown
Signal reference	Blue
Signal output	Black

The cable is not supplied with the pump but can be ordered as an accessory.



The cable must be connected to the control box via a mini superseal plug. See fig. 20.



Fig. 20 Mini superseal plug

Set the signal connection

1. Make sure that the pump is turned off.
2. Locate the PWM signal connection on the pump.
The three pins inside the signal connection are not energised.
3. Connect the signal cable with the mini superseal plug.
4. Switch on the power supply.
5. The pump automatically detects if a valid PWM signal is available after which it enables the control mode on the pump. See fig. 8. If the pump does not detect a PWM signal or if the signal equals 0, the pump will switch to the control mode selected before connecting to a PWM signal.



1 x 230 V - 15% / + 10 %
~ 50/60 Hz Ⓢ

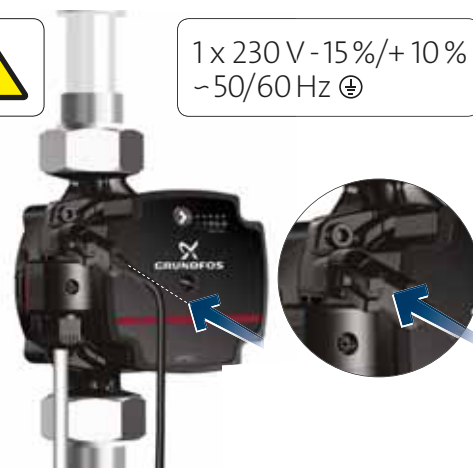

Fig. 21 Connecting the signal cable to UPS3

TM064414

TM07 0379 1518

8. Servicing the product



DANGER

Electric shock

Death or serious personal injury

- All electrical connections must be carried out by a qualified electrician in accordance with local regulations.



DANGER

Electric shock

Death or serious personal injury

- Switch off the power supply before starting any work on the product. Make sure that the power supply cannot be accidentally switched on.



CAUTION

Hot surface

Minor or moderate personal injury

- The pump housing may be hot due to the pumped liquid being scalding hot. Close the isolating valves on both sides of the pump and wait for the pump housing to cool down.



CAUTION

Pressurised system

Minor or moderate personal injury

- Before dismantling the pump, drain the system or close the isolating valves on both sides of the pump. The pumped liquid may be scalding hot and under high pressure.



All service must be carried out by an instructed service technician.

8.1 Dismantling the product

1. Switch off the power supply.
2. Pull out the plug. For instructions on how to dismantle the plug, see section [8.2 Dismantling the plug](#).
3. Close the two isolating valves on both sides of the pump.
4. Loosen the fittings.
5. Remove the pump from the system.

8.2 Dismantling the plug

1. Loosen the cable gland and unscrew the union nut in the centre of the terminal cover.
2. Detach the terminal cover.
3. Loosen the screws on the power supply plug and disconnect the cable conductors.
4. Pull the power cable back through the cable gland and terminal cover.

9. Fault finding the product

If the pump has detected one or more alarms, the first LED switches from green to red. When an alarm is active, the LEDs indicate the alarm type as defined in fig. 22.



If multiple alarms are active at the same time, the LEDs only show the error with the highest priority. The priority is defined by the sequence of the table.

When there is no active alarm anymore, the operating panel switches back to operating status and the first LED switches from red to green.

DANGER

Electric shock

Death or serious personal injury

- Switch off the power supply before starting any work on the product. Make sure that the power supply cannot be accidentally switched on.



CAUTION

Hot surface

Minor or moderate personal injury

- The pump housing may be hot due to the pumped liquid being scalding hot. Close the isolating valves on both sides of the pump and wait for the pump housing to cool down.



CAUTION

Pressurised system

Minor or moderate personal injury

- Before dismantling the pump, drain the system or close the isolating valves on both sides of the pump. The pumped liquid may be scalding hot and under high pressure.



Display	Status	Solution
	Alarm The pump stops. The pump is blocked.	Deblock the shaft. See section 9.1 <i>Deblocking the shaft</i> .
	Warning The pump keeps running. The supply voltage is low.	Make sure that there is sufficient voltage supply to the pump.
	Alarm The pump stops. Electrical error.	Replace the pump and return the pump your supplier.

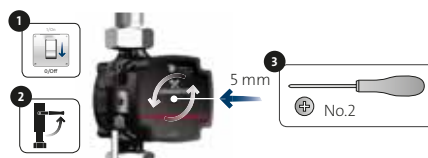

Fig. 22 Fault finding table

9.1 Deblocking the shaft

If the pump is blocked it is necessary to deblock the shaft. The pump deblocking device is accessible from the front of the pump without having to demount the control box. The force of the device is high enough to deblock pumps, which are seized by lime, for example if the pump has been turned off during summer.

Course of action:

1. Switch off the power supply.
2. Close the valves.
3. Locate the deblocking screw in the centre of the control box. Use a star screwdriver with a size 2 Phillips tip to push the deblocking screw inwards.
4. When the screw can be turned counterclockwise, the shaft has been deblocked. Repeat step 3, if necessary.

5. Switch on the power supply.

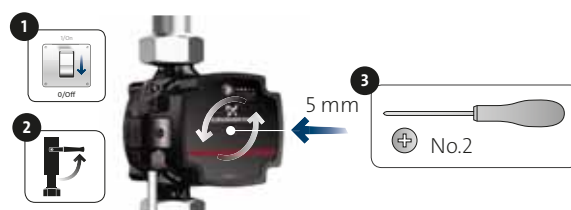

Fig. 23 Deblocking the shaft



Before, during and after the deblocking, the device is tight and must not release any water.

TM07 0387 1518

10. Technical data

Operating conditions		
Sound pressure level	The sound pressure level of the pump is lower than 32 dB(A).	
Relative humidity	Maximum 95 %, non-condensing environment	
System pressure	PN 10: Maximum 1.0 MPa (10 bar)	
Inlet pressure	Liquid temperature	
	Minimum inlet pressure	
	75 °C	0.005 MPa, 0.05 bar, 0.5 m head
	95 °C	0.05 MPa, 0.5 bar, 5 m head
Maximum inlet pressure	1 MPa (10 bar)	
Ambient temperature	0-55 °C	
Liquid temperature	2-95 °C	
Liquid	Maximum water/propylene glycol mixture is 50 %	
Viscosity	Maximum 10 mm ² /s	
Maximum altitude of installation	2000 m above sea level	
Electrical data		
Supply voltage	1 x 230 V - 15 %/+ 10 %, 50/60 Hz, PE	
Insulation class	F	
Standby power consumption	< 1 W	
Inrush current	< 4 A	
Minimum switching time power on/off	No specific requirements	
Miscellaneous data		
Motor protection	The pump requires no external motor protection.	
Enclosure class	IPX4D	
Temperature class (TF)	TF95	
Specific EEI values	UPS3 15-50/65: EEI ≤ 0.20	

To avoid condensation in the stator, the liquid temperature must always be higher than the ambient temperature.

Reduced supply voltage

The pump operation is ensured above 160 VAC with reduced performance. If the voltage falls below 190 VAC, a low-voltage warning is sent via the PWM signal. If the voltage falls below 150 VAC, the pump stops and shows an alarm.

10.1 Dimensions, UPS3 15-50/65

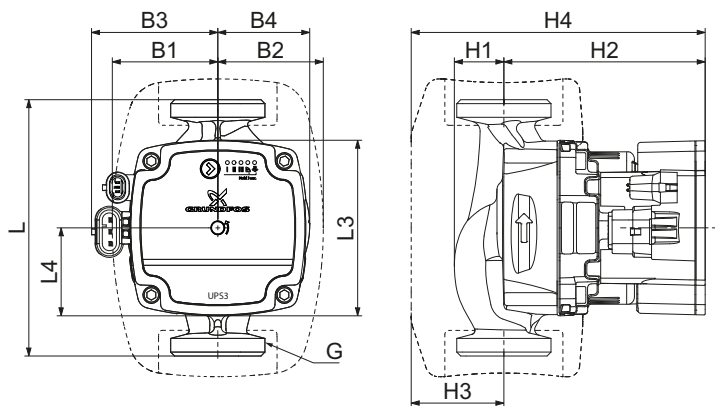

Fig. 24 UPS3 15-50/65

Pump type	Dimensions [mm]											
	L	L3	L4	B1	B2	B3	B4	H1	H2	H3	H4	G
UPS3 15-50/65	130	89	45	54	54	64	47	25	102	47	149	G 1 1/2

11. Performance curves

Each pump has its own performance curve.

A power curve, P1, belongs to each performance curve. The power curve shows the pump power consumption in watt at a given performance.

11.1 Curve conditions

The guidelines below apply to the performance curves on the following pages:

- Test liquid: airless water.
- The curves apply to a density of $\rho = 983.2 \text{ kg/m}^3$ and a liquid temperature of $60 \text{ }^\circ\text{C}$.
- All curves show average values and must not be used as guarantee curves. If a specific minimum performance is required, individual measurements must be made.
- The curves for speeds I, II and III are marked.
- The curves apply to a kinematic viscosity of $\nu = 0.474 \text{ mm}^2/\text{s}$ (0.474 cSt).
- The EEI values obtained according to EN 16297 part 3.

11.2 Performance curve, UPS3 15-50/65

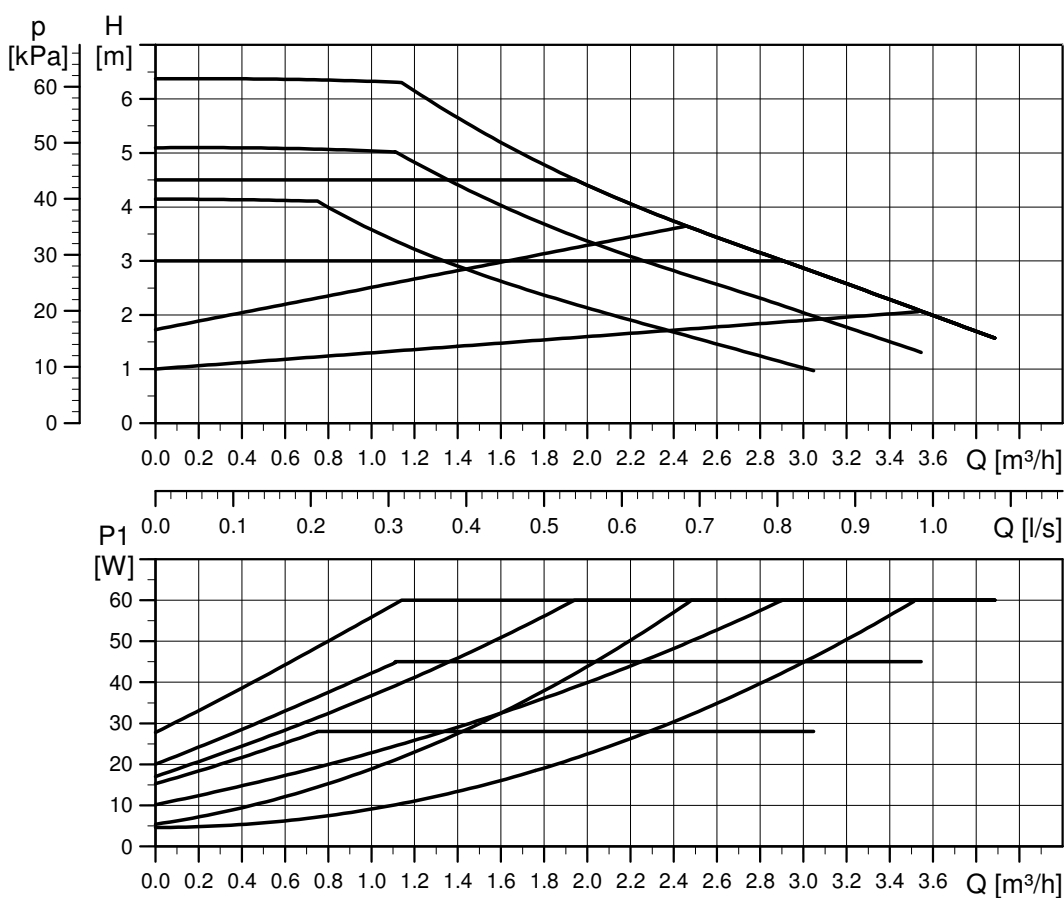

Setting	P1 [W]	I ₁ [A]
Min.	4	0.05
Max.	60	0.52

TM07 0800 1318

12. Disposing of the product

This product or parts of it must be disposed of in an environmentally sound way:

1. Use the public or private waste collection service.
2. If this is not possible, contact your supplier.



The crossed-out wheellie bin symbol on a product means that it must be disposed of separately from household waste. When a product marked with this symbol reaches its end of life, take it to a collection point designated by the local waste disposal

authorities. The separate collection and recycling of such products will help protect the environment and human health.

See also end-of-life information at www.grundfos.com/product-recycling.

Argentina

Bombas GRUNDFOS de Argentina S.A.
Ruta Panamericana km. 37.500 Centro Industrial Garin
1619 Garin Pcia. de B.A.
Phone: +54-3327 414 444
Telefax: +54-3327 45 3190

Australia

GRUNDFOS Pumps Pty. Ltd.
P.O. Box 2040
Regency Park
South Australia 5942
Phone: +61-8-8461-4611
Telefax: +61-8-8340 0155

Austria

GRUNDFOS Pumpen Vertrieb Ges.m.b.H.
Grundfosstraße 2
A-5082 Grödig/Salzburg
Tel.: +43-6246-883-0
Telefax: +43-6246-883-30

Belgium

N.V. GRUNDFOS Bellux S.A.
Boomssesteenweg 81-83
B-2630 Aartselaar
Tél.: +32-3-870 7300
Télécopie: +32-3-870 7301

Belarus

Представительство ГРУНДФОС в Минске
220125, Минск
ул. Шафарнянская, 11, оф. 56, БЦ «Порт»
Тел.: +375 17 397 397 3
+375 17 397 397 4
Факс: +375 17 397 397 1
E-mail: minsk@grundfos.com

Bosnia and Herzegovina

GRUNDFOS Sarajevo
Zmaj od Bosne 7-7A,
BH-71000 Sarajevo
Phone: +387 33 592 480
Telefax: +387 33 590 465
www.ba.grundfos.com
e-mail: grundfos@bih.net.ba

Brazil

BOMBAS GRUNDFOS DO BRASIL
Av. Humberto de Alencar Castelo Branco, 630
CEP 09850 - 300
São Bernardo do Campo - SP
Phone: +55-11 4393 5533
Telefax: +55-11 4343 5015

Bulgaria

Grundfos Bulgaria EOOD
Slatina District
Iztochna Tangenta street no. 100
BG - 1592 Sofia
Tel. +359 2 49 22 200
Fax. +359 2 49 22 201
email: bulgaria@grundfos.bg

Canada

GRUNDFOS Canada Inc.
2941 Brighton Road
Oakville, Ontario
L6H 6C9
Phone: +1-905 829 9533
Telefax: +1-905 829 9512

China

GRUNDFOS Pumps (Shanghai) Co. Ltd.
10F The Hub, No. 33 Suhong Road
Minhang District
Shanghai 201106
PRC
Phone: +86 21 612 252 22
Telefax: +86 21 612 253 33

COLOMBIA

GRUNDFOS Colombia S.A.S.
Km 1.5 vía Siberia-Cota Conj. Potrero Chico,
Parque Empresarial Arcos de Cota Bod. 1A.
Cota, Cundinamarca
Phone: +57(1)-2913444
Telefax: +57(1)-8764586

Croatia

GRUNDFOS CROATIA d.o.o.
Buzinski prilaz 38, Buzin
HR-10010 Zagreb
Phone: +385 1 6595 400
Telefax: +385 1 6595 499
www.hr.grundfos.com

GRUNDFOS Sales Czechia and Slovakia s.r.o.

Čajkovského 21
779 00 Olomouc
Phone: +420-585-716 111

Denmark

GRUNDFOS DK A/S
Martin Bachs Vej 3
DK-8850 Bjerringbro
Tlf.: +45-87 50 50 50
Telefax: +45-87 50 51 51
E-mail: info_GDK@grundfos.com
www.grundfos.com/DK

Estonia

GRUNDFOS Pumps Eesti OÜ
Peterburi tee 92G
11415 Tallinn
Tel: + 372 606 1690
Fax: + 372 606 1691

Finland

OY GRUNDFOS Pumpat AB
Trukkikuja 1
FI-01360 Vantaa
Phone: +358-(0) 207 889 500

France

Pompes GRUNDFOS Distribution S.A.
Parc d'Activités de Chesnes
57, rue de Malacombe
F-38290 St. Quentin Fallavier (Lyon)
Tél.: +33-4 74 82 15 15
Télécopie: +33-4 74 94 10 51

Germany

GRUNDFOS GMBH
Schlüterstr. 33
40699 Erkrath
Tel.: +49-(0) 211 929 69-0
Telefax: +49-(0) 211 929 69-3799
e-mail: infoservice@grundfos.de
Service in Deutschland:
e-mail: kundendienst@grundfos.de

Greece

GRUNDFOS Hellas A.E.B.E.
20th km. Athinon-Markopoulou Av.
P.O. Box 71
GR-19002 Peania
Phone: +0030-210-66 83 400
Telefax: +0030-210-66 46 273

Hong Kong

GRUNDFOS Pumps (Hong Kong) Ltd.
Unit 1, Ground floor
Siu Wai Industrial Centre
29-33 Wing Hong Street &
68 King Lam Street, Cheung Sha Wan
Kowloon
Phone: +852-27861706 / 27861741
Telefax: +852-27858664

Hungary

GRUNDFOS Hungária Kft.
Tópark u. 8
H-2045 Törökbálint,
Phone: +36-23 511 110
Telefax: +36-23 511 111

India

GRUNDFOS Pumps India Private Limited
118 Old Mahabalipuram Road
Thoraiakkam
Chennai 600 096
Phone: +91-44 2496 6800

Indonesia

PT. GRUNDFOS POMPA
Graha Intirub Lt. 2 & 3
Jln. Cililitan Besar No.454. Makasar,
Jakarta Timur
ID-Jakarta 13650
Phone: +62 21-469-51900
Telefax: +62 21-460 6910 / 460 6901

Ireland

GRUNDFOS (Ireland) Ltd.
Unit A, Merrywell Business Park
Ballymount Road Lower
Dublin 12
Phone: +353-1-4089 800
Telefax: +353-1-4089 830

Italy

GRUNDFOS Pompe Italia S.r.l.
Via Gran Sasso 4
I-20060 Truccazzano (Milano)
Tel.: +39-02-95838112
Telefax: +39-02-95309290 / 95838461

Japan

GRUNDFOS Pumps K.K.
1-2-3, Shin-Miyakoda, Kita-ku,
Hamamatsu
431-2103 Japan
Phone: +81 53 428 4760
Telefax: +81 53 428 5005

Korea

GRUNDFOS Pumps Korea Ltd.
6th Floor, Aju Building 679-5
Yeoksam-dong, Kangnam-ku, 135-916
Seoul, Korea
Phone: +82-2-5317 600
Telefax: +82-2-5633 725

Latvia

SIA GRUNDFOS Pumps Latvia
Deglava biznesa centrs
Augusta Deglava ielā 60, LV-1035, Rīga,
Tālr.: + 371 714 9640, 7 149 641
Fakss: + 371 914 9646

Lithuania

GRUNDFOS Pumps UAB
Smolensko g. 6
LT-03201 Vilnius
Tel: + 370 52 395 430
Fax: + 370 52 395 431

Malaysia

GRUNDFOS Pumps Sdn. Bhd.
7 Jalan Peguam U1/25
Glenmarie Industrial Park
40150 Shah Alam
Selangor
Phone: +60-3-5569 2922
Telefax: +60-3-5569 2866

Mexico

Bombas GRUNDFOS de México S.A. de C.V.
Boulevard TLC No. 15
Parque Industrial Stiva Aeropuerto
Apodaca, N.L. 66600
Phone: +52-81-8144 4000
Telefax: +52-81-8144 4010

Netherlands

GRUNDFOS Netherlands
Veluwezoom 35
1326 AE Almere
Postbus 22015
1302 CA ALMERE
Tel.: +31-88-478 6336
Telefax: +31-88-478 6332
E-mail: info_gnl@grundfos.com

New Zealand

GRUNDFOS Pumps NZ Ltd.
17 Beatrice Tinsley Crescent
North Harbour Industrial Estate
Albany, Auckland
Phone: +64-9-415 3240
Telefax: +64-9-415 3250

Norway

GRUNDFOS Pumper A/S
Stremsveien 344
Postboks 235, Leirdal
N-1011 Oslo
Tlf.: +47-22 90 47 00
Telefax: +47-22 32 21 50

Poland

GRUNDFOS Pompy Sp. z o.o.
ul. Klonowa 23
Baranowo k. Poznania
PL-62-081 Przeźmierowo
Tel: (+48-61) 650 13 00
Fax: (+48-61) 650 13 50

Portugal

Bombas GRUNDFOS Portugal, S.A.
Rua Calvet de Magalhães, 241
Apartado 1079
P-2770-153 Paço de Arcos
Tel.: +351-21-440 76 00
Telefax: +351-21-440 76 90

Romania

Grundfos Pompe România SRL
S-PARK BUSINESS CENTER, Clădirea A2,
etaj 2, Str. Tipografilor, Nr. 11-15, Sector 1,
Cod 013714, Bucuresti, Romania,
Tel: 004 021 2004 100
E-mail: romania@grundfos.ro
www.grundfos.ro

Russia

ООО Грундфос Россия
ул. Школьная, 39-41
Москва, RU-109544, Russia
Тел. (+7) 495 564-88-00 (495) 737-30-00
Факс (+7) 495 564 8811
E-mail grundfos.moscow@grundfos.com

Serbia

Grundfos Srbija d.o.o.
Omladinskih brigada 90b
11070 Novi Beograd
Phone: +381 11 2258 740
Telefax: +381 11 2281 769
www.rs.grundfos.com

Singapore

GRUNDFOS (Singapore) Pte. Ltd.
25 Jalan Tukang
Singapore 619264
Phone: +65-6681 9688
Telefax: +65-6681 9689

Slovakia

GRUNDFOS s.r.o.
Prievozská 4D
821 09 BRATISLAVA
Phona: +421 2 5020 1426
sk.grundfos.com

Slovenia

GRUNDFOS LJUBLJANA, d.o.o.
Leskoškova 9e, 1122 Ljubljana
Phone: +386 (0) 1 568 06 10
Telefax: +386 (0) 1 568 06 19
E-mail: tehnika-si@grundfos.com

South Africa

Grundfos (PTY) Ltd.
16 Lascelles Drive, Meadowbrook Estate
1609 Germiston, Johannesburg
Tel.: (+27) 10 248 6000
Fax: (+27) 10 248 6002
E-mail: lgradidge@grundfos.com

Spain

Bombas GRUNDFOS España S.A.
Camino de la Fuentequilla, s/n
E-28110 Algete (Madrid)
Tel.: +34-91-848 8800
Telefax: +34-91-628 0645

Sweden

GRUNDFOS AB
Box 333 (Lunnagårdsgatan 6)
431 24 Mölndal
Tel.: +46 31 332 23 000
Telefax: +46 31 331 94 60

Switzerland

GRUNDFOS Pumpen AG
Bruggacherstrasse 10
CH-8117 Fällanden/ZH
Tel.: +41-44-806 8111
Telefax: +41-44-806 8115

Taiwan

GRUNDFOS Pumps (Taiwan) Ltd.
7 Floor, 219 Min-Chuan Road
Taichung, Taiwan, R.O.C.
Phone: +886-4-2305 0868
Telefax: +886-4-2305 0878

Thailand

GRUNDFOS (Thailand) Ltd.
92 Chaloe Phrakiat Rama 9 Road,
Dokmai, Pravej, Bangkok 10250
Phone: +66-2-725 8999
Telefax: +66-2-725 8998

Turkey

GRUNDFOS POMPA San. ve Tic. Ltd. Sti.
Gebze Organize Sanayi Bölgesi
Ihsan dede Caddesi,
2. yol 200. Sokak No. 204
41490 Gebze/ Kocaeli
Phone: +90 - 262-679 7979
Telefax: +90 - 262-679 7905
E-mail: satis@grundfos.com

Ukraine

Бізнес Центр Європа
Столицне шосе, 103
м. Київ, 03131, Україна
Телефон: (+38 044) 237 04 00
Факс.: (+38 044) 237 04 01
E-mail: ukraine@grundfos.com

United Arab Emirates

GRUNDFOS Gulf Distribution
P.O. Box 16768
Jebel Ali Free Zone
Dubai
Phone: +971 4 8815 166
Telefax: +971 4 8815 136

United Kingdom

GRUNDFOS Pumps Ltd.
Grovebury Road
Leighton Buzzard/Beds. LU7 4TL
Phone: +44-1525-850000
Telefax: +44-1525-850011

U.S.A.

GRUNDFOS Pumps Corporation
9300 Loiret Blvd.
Lenexa, Kansas 66219
Phone: +1-913-227-3400
Telefax: +1-913-227-3500

Uzbekistan

Grundfos Tashkent, Uzbekistan The Representative Office of Grundfos Kazakhstan in Uzbekistan
38a, Oybek street, Tashkent
Телефон: (+998) 71 150 3290 / 71 150 3291
Факс: (+998) 71 150 3292

Addresses Revised 09.09.2020

99423997 12.2020

ECM: 1303119

Trademarks displayed in this material, including but not limited to Grundfos, the Grundfos logo and "be think innovate" are registered trademarks owned by The Grundfos Group. All rights reserved. © 2020 Grundfos Holding A/S. All rights reserved.